

# Tunnelling under the Mugello Motor Racing Circuit incorporating the ADECO-RS Approach

Prof. Eng. Pietro Lunardi

Considerable problems had to be solved in driving the Firenzuola Tunnel on the new high-speed rail line between Bologna and Florence when it passed under the Mugello international motor racing circuit with difficult ground conditions under a very shallow overburden.



1 Bird's eye view of the Mugello international motor racing circuit, which was underpassed by the new Bologna–Florence high-speed rail line

survey techniques and in tunnel advance and stabilisation systems and these are now capable of successfully tackling all types of ground and stress-strain conditions (horizontal jet-grouting, mechanical pre-cutting, reinforcement of the advance core using fibre glass structural elements, etc.). This progress constituted an indispensable precondition for a consideration of rational approaches to design and construction that would allow the design of underground works before construction begins and reliable forecasting of construction times and costs, as has always been normal practice with

## 1 Introduction

The main difficulties faced in planning underground works have always been those of reliably predicting the geological and geo-mechanical characteristics of the ground to be tunnelled and the lack of effective technical instruments for tackling the poorest ground.

Over the last 15 years, however, important progress has been made in geological

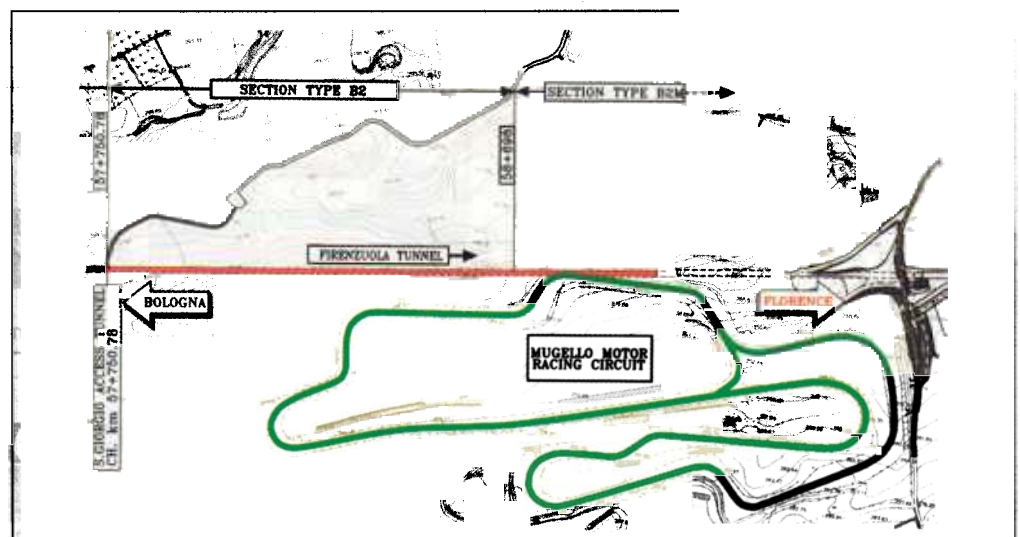

2 Firenzuola Tunnel passing under the Mugello international motor racing circuit

Prof. Eng. Pietro Lunardi,  
Lunardi Geo-engineering  
Design Office, Milan/I

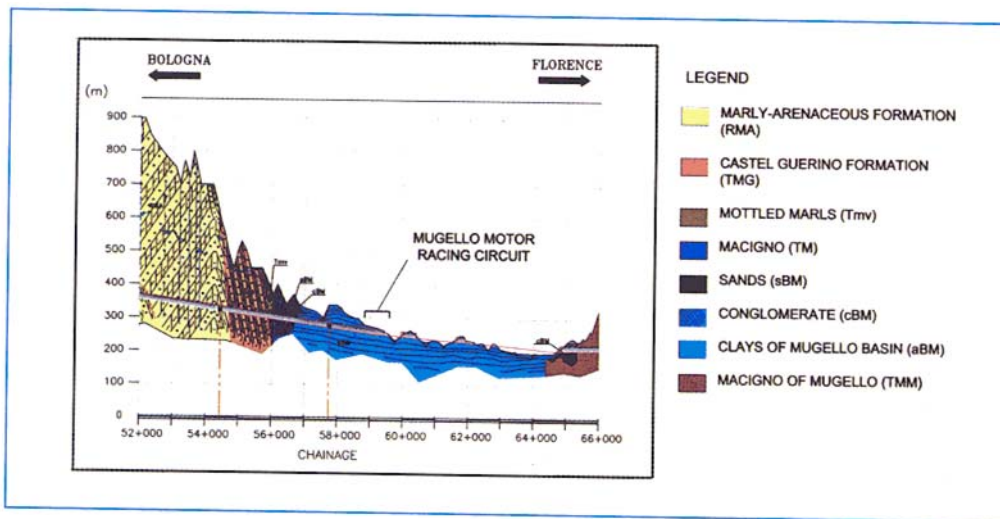

3 Section of the Firenzeuola Tunnel passing under the Mugello international motor racing circuit

other types of civil engineering works.

ADECO-RS (Analisi delle Deformazioni Controllate nelle Rocce e nei Suoli/Analysis of controlled deformation in Rocks and Soils), an innovative design and construction approach, was first proposed over 10 years ago. It focuses the attention of the design engineer on the deformation response of the medium to excavation.

This response is analysed beforehand and predicted using the available instruments (full scale in situ and laboratory measurements, numerical analysis, etc.) and then controlled by means of appropriate intervention to stabilise the tunnel.

As opposed to traditional NATM derived approaches, which consider only deformation that occurs in the tunnel behind the face, the Adeco-RS approach studies the deformation response from the moment it begins ahead of the face and then naturally also in the tunnel. It recognises, on the basis of fifteen years of theoretical and experimental research, that deformation develops in the form of extrusion at the face, pre-convergence and then finally as convergence.

As a consequence, the Adeco-RS approach controls this response by acting above all ahead of the face with pre-confinement of the cavity and not just ordinary confinement in the tunnel behind the face as is done with traditional approaches. Pre-confinement is performed by using the core of ground ahead of the face (appropriately protected or reinforced) as a structural element for stabilising the tunnel during the stages of tunnel advance and construction.

In this manner, the approach is able for the first time

to successfully tackle all types of ground in all stress-strain conditions, including the most difficult and since the design can be checked and calibrated during construction by comparing uniform parameters (deformation response predicted by calculations and actual deformation response measured), a remedy is found to what has always been a major defect of traditional approaches: they compare parameters different in nature (geo-mechanical classes with deformation responses).

Another important characteristic of the Adeco-RS approach that distinguishes it from traditional methods is that it is based on a clear distinction between the design and the construction moments of a project. This makes it possible to produce reliable estimates of costs and times for underground works, just as with surface projects. As a consequence, clients and contractors are starting to sign turnkey contracts in which the contractors accept all the risks including geological risks.

This is in fact the case of the underground works currently underway for the construction of the high-speed railway line running under the Apennines between Bologna and Florence (a total of more than 102 km of access, service and running tunnels) for which all the contracts awarded are of this type, based entirely on very detailed final design specifications compiled according to Adeco-RS principles.

While readers interested in a more exhaustive discussion of this approach are referred to the publications in the bibli-

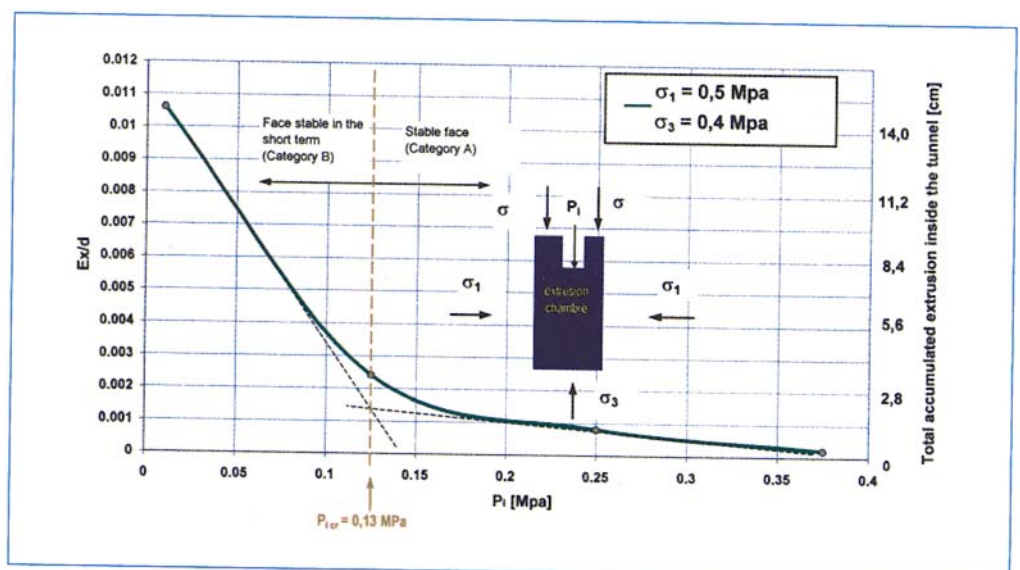

4 Prediction of the behaviour category using tri-axial extrusion tests (diagnosis phase)

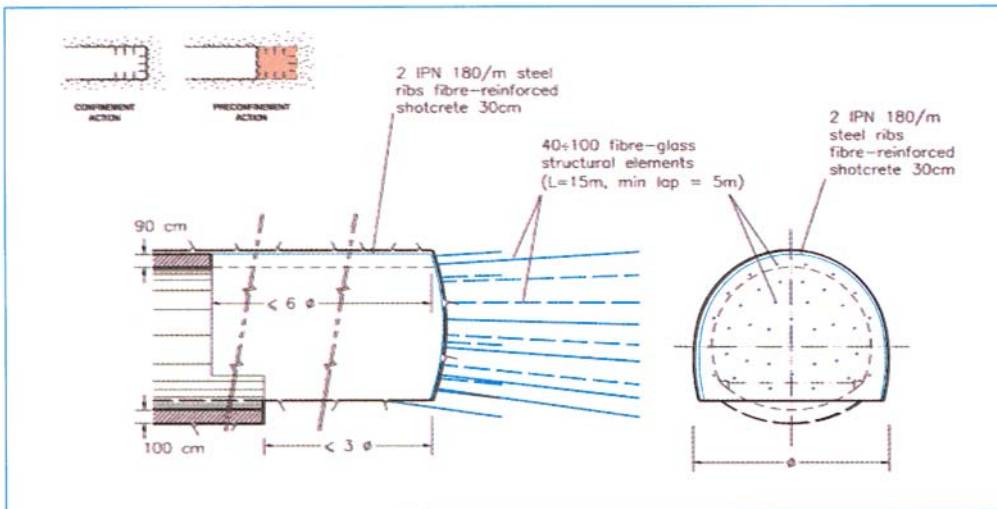

5 Firenzuola Tunnel passing under the Mugello international motor racing circuit: Section type B2 (therapy phase)

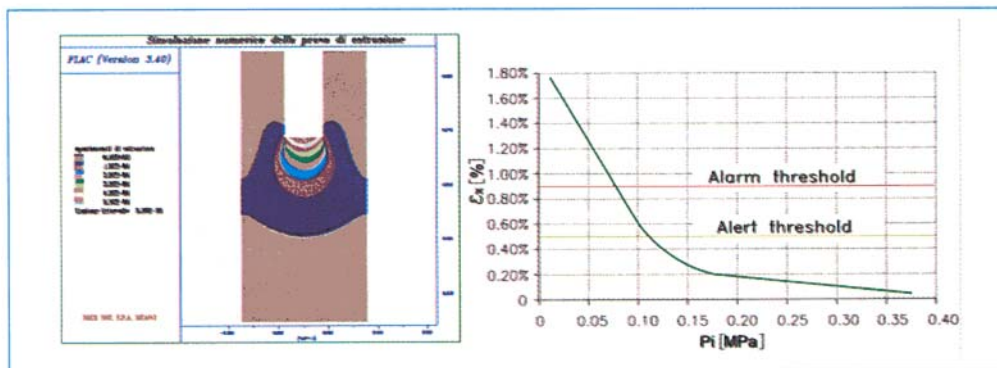

6 Setting of alert and alarm thresholds by using tri-axial extrusion tests (reconstructed by means of an axial-symmetric model) (monitoring phase)

ography at the end of the article, here we have illustrated one significant practical application, which shows how the approach lends itself to the correct application of observational principles to calibrate and optimise design during construction.

## 2 The geological, geotechnical and hydrogeological Picture (Survey Stage)

The area in which the tunnel passes under the racing circuit is located in the Mugello Basin and crosses the valley created by the Bagnone river at an angle (Figs. 1, 2). From a

geological viewpoint the ground to be tunnelled belongs to the Clays of Mugello Basin (Argille del Bacino del Mugello) formation (aBM), which consist of Pleistocene fluvial-lacustrine deposits with sub-horizontal stratifica-

tion. They are clayey silts, slightly sandy and grey-blue in colour, with a compact structure, neither weathered nor oxidised, with scattered peaty blackish and level lentils or lentils of fine sand mixed with silt. An alluvial or eluvial de-



7 Bend of the Mugello international motor racing circuit

posit consisting of sands, gravels and thick conglomerates of fan-shaped structures covers the surface (Fig. 3).

From a geotechnical viewpoint, the Clays of Mugello Basin can be classified as inorganic clays of medium-low plasticity (CL) and good consistency, slightly over-consolidated (OCR between 2 and 5). The strength and deformation parameters of the material were investigated under drained and undrained conditions using simple and tri-axial compression tests (CD and CU and UU). These gave values for undrained cohesion which increased with depth and which in any case lay between 0,1 and 0,5 MPa. Under drained conditions the strength of the material under intense stress fell rapidly in two distinct phases:

- when peak strength values were reached, after small relative slipping, the bonds between the particles that confer effective cohesion  $c'$  on the material were destroyed, while there was no change in the effective angle of friction with respect to the peak value
- after greater relative slipping, the angle of friction fell to residual values.

To summarise, the investigations on the first analysis produced the following geotechnical parameters:

- unit weight: 19.9–20 kN/m<sup>3</sup>
- effective peak cohesion: 0.02–0.03 MPa
- residual effective cohesion: 0
- peak effective angle of friction: 24°–28°
- residual effective angle of friction: 15°–18°

The elastic modulus, estimated on the basis of pressure meter tests was linearly proportional to the depth according to the law:

$$E(z) = 11,5 + 3,02 \cdot z \quad [\text{MPa}]$$

The coefficient of consolidation (Cv), obtained using

consolidation tests was also found to vary with depth ranging from  $5 \times 10^{-7}$  and  $3 \times 10^{-7}$  m/s.

Finally a few extrusion tests were performed in a tri-axial cell; the results are given in Fig. 4.

From a hydrogeological viewpoint, the Clays of the Mugello Basin are basically an impermeable formation although it does contain levels and lentils of sand up to 3 m thick, which may hold, confined water. A series of piezometer tubes installed along the route of the tunnel detected confined water with a piezometric line that tended to rise more or less following the interface between the overlying alluvial deposits and the clays beneath. At tunnel depth, the piezometric surface is approximately 40 m at the point of the greatest overburden.

### 3 Diagnosis Phase

In this phase analysis of the deformation response of the ground to excavation in the absence of intervention to stabilise the tunnel found core-face behaviour stable in the short term (behaviour category B) (Fig. 4). This condition,

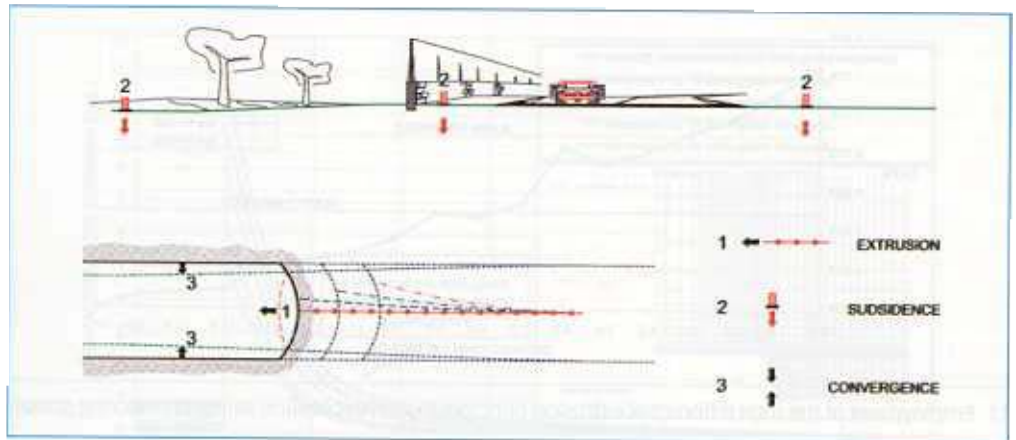

8 Types of measurements performed when approaching the racing circuit (monitoring phase)

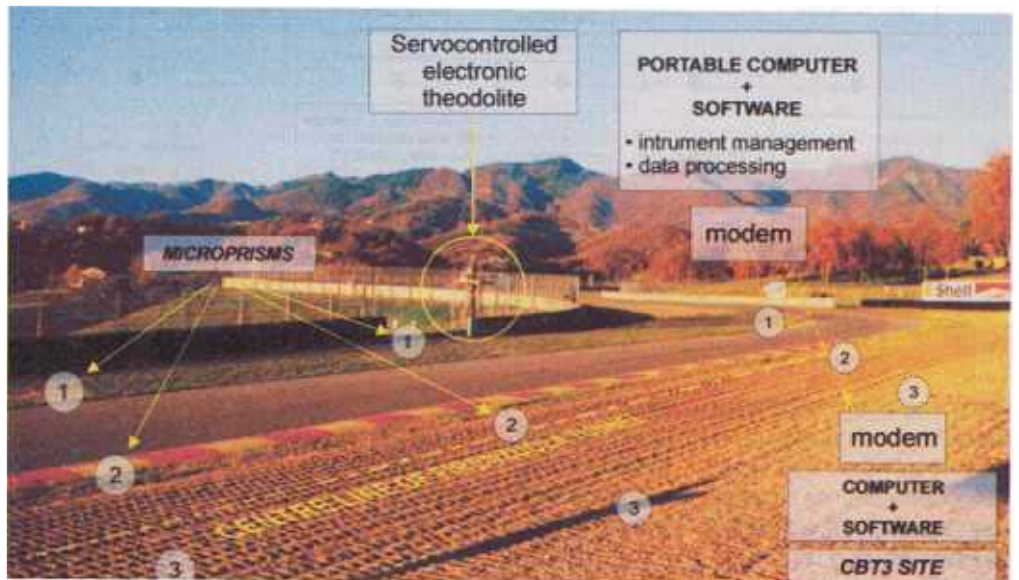

9 Topographic surface monitoring along the racing circuit (monitoring phase)

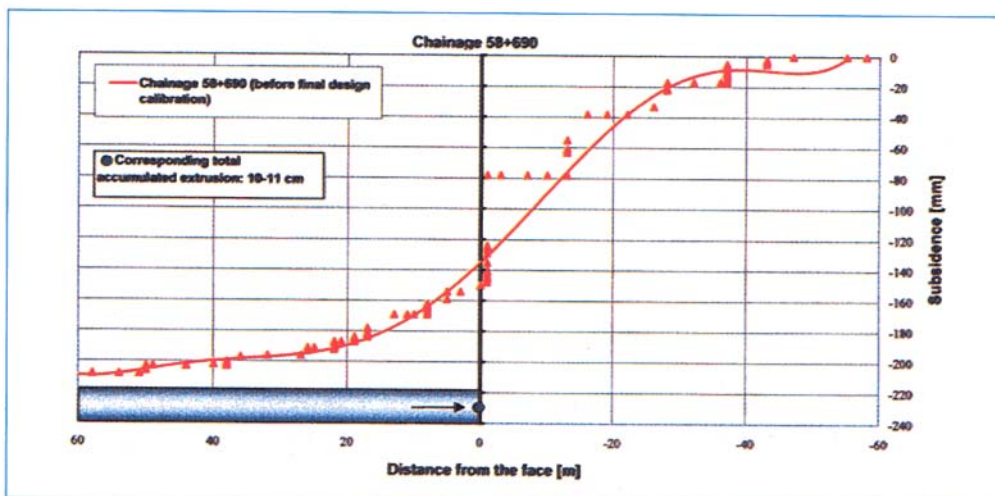

10 Longitudinal subsidence as a function of distance from the face (monitoring phase)

as is known, occurs when the stress state in the ground at the face and around the cavity during tunnel advance is sufficient to overcome the capacity of the medium to resist it in the elastic range. Deformation therefore develops in the elastic-plastic range and as a consequence an "arch effect" is not created close to the cavity but at a distance from it depending on the size of the band of ground that is subject to plasticisation.

In this situation the stability of the face is strongly affected by the speed of tunnel ad-

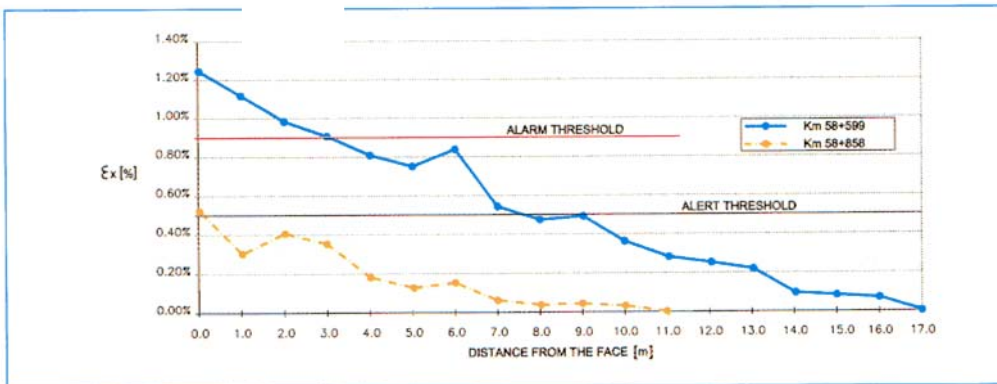

11 Employment of the total differential extrusion principle to gain excavation safety (monitoring phase)

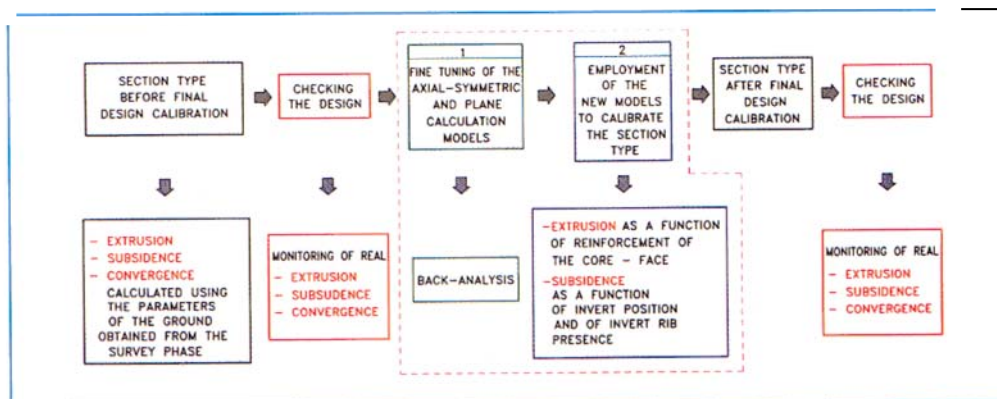

12 Main stages for the final design calibration

vance and given the shallow overburden, deformation in the core manifesting as extrusion would give rise to unacceptable subsidence if not adequately contained.

#### 4 The Therapy Phase

In this phase the design problem to be solved was how to develop design and construction stratagems which would ensure that surface subsidence caused by excavation and possible damage to the road surface of the racing track would be adequately contained especially considering the reduced overburden (from 20 m to 60 m), the particular geomorphology of the area and the geological and geotechnical features of the alluvial deposits of the Mugello Basin. With regard to the

racing track, the design also had to take account of the calendar of racing events of various types and the absolutely imperative requirement for the racing track to be in perfect condition ready for approval inspection well before

the World Motorcycle Championship (April–May 2000).

All the various requirements were taken into account and the resulting construction design specified the following type of advance (Fig. 5), which would then have to

be calibrated on the basis of monitoring measurements during construction:

1. full-face advance after first stiffening the core by placing 40–100 fibre glass structural elements:  $L \geq 15$  m, overlap  $\geq 5$  m and cementing them using controlled shrinkage mixes or expanding cement
2. preliminary lining composed of 21PN 180 steel ribs at intervals of 1.00–1.40 m and a 30 cm layer of fibre reinforced shotcrete
3. a tunnel invert, 100 cm thick, cast at the same time as the kickers at a maximum distance of 3 diameters from the face
4. a final concrete lining, 90 cm thick in the roof, cast at a maximum distance of 6 diameters from the face.

The deformation values predicted and considered acceptable by the design were 5 cm for total accumulated extrusion and 8 cm for average radial convergence. As for total differential extrusion the following maximum limits were set: 0.5 % for the alert threshold and 0.9 % for the alarm threshold (Fig. 6).

#### 5 The Monitoring Programme

Considering the delicacy of the situation, as the racing

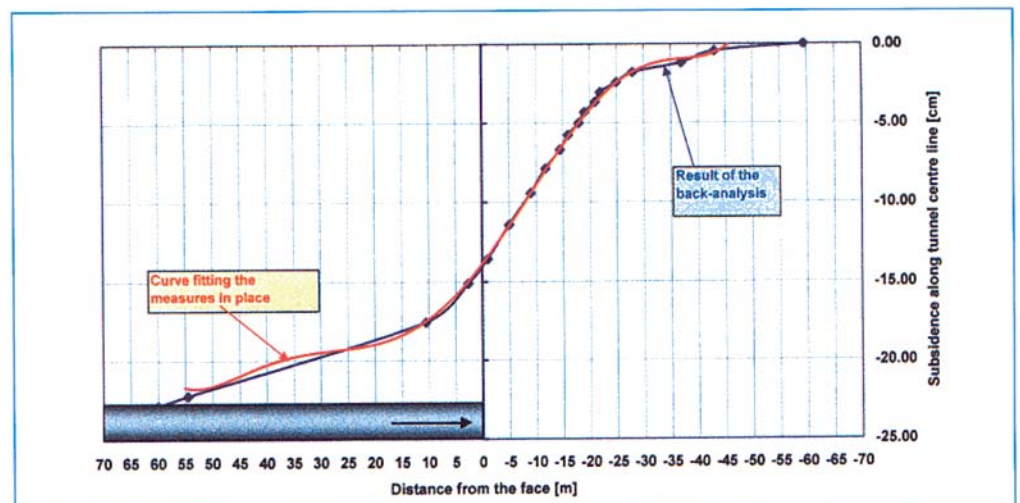

13 Reconstruction of the real situation by using an axial-symmetric model (monitoring phase)

track was approached in June 1999, a real time monitoring programme was set up as stipulated in the design specifications – also for the purpose of ensuring the safety necessary for the racing circuit to be able to adhere to its schedule of events.

The deformation response of the ground to excavation was monitored accurately both from inside the cavity and from the surface. Inside the tunnel it was analysed by systematic measurement of extrusion at the face (using both a sliding micrometer and topographical survey type measurements) and of cavity convergence and it was studied from the surface using real time topographical measurements of subsidence induced by the passage of the face.

The external monitoring system which was designed and created by the design team (Rocksoil S.p.A. of Milan) together with the Treese Consortium, was structured so that a series of optical targets could be automatically hit at hourly intervals from a specially constructed "light house" located near the zone

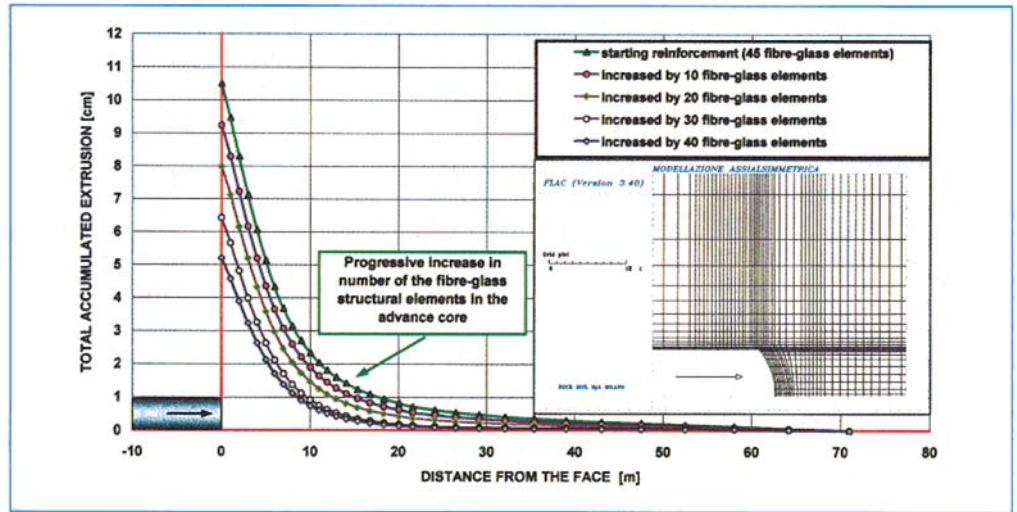

14 Optimisation of the advance core reinforcement using axial-symmetric models (monitoring phase)

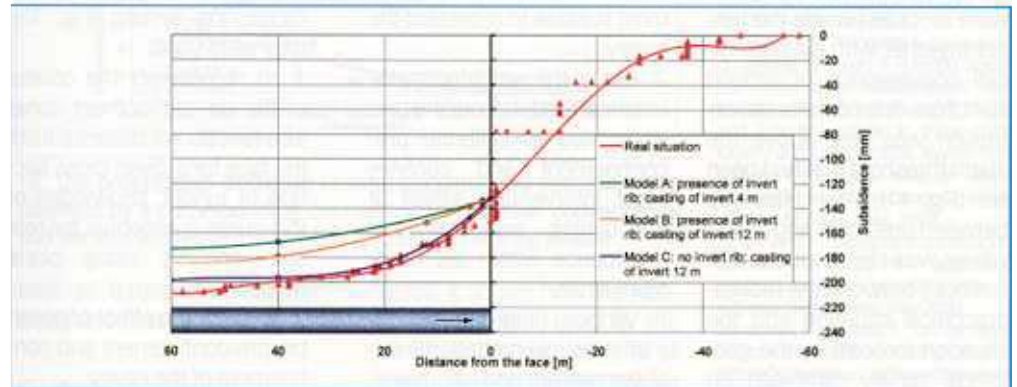

15 Optimisation of the intervention in the advance core and in the cavity (monitoring phase)

where the tunnel passes under the racing circuit. The tar-

gets were positioned in a 10 x 5 m grid pattern on the ground

over the centre line of the approaching tunnel before and after the point where the route crosses the racing track near the "Borgo San Lorenzo" curve (figures 7, 8 and 9). The data obtained was transmitted in real time to a control centre where it was immediately processed and transmitted to the design team on the construction site.

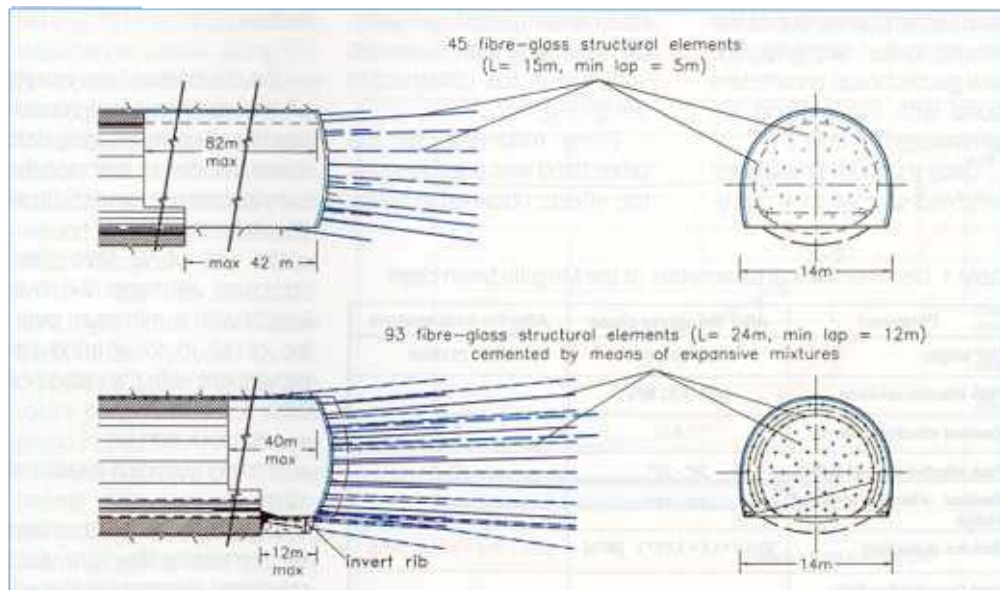

16 Section type B2 before (top) and after final design calibration (monitoring phase)

## 6 Calibration of the Design on the Basis of Monitoring Data

The monitoring system showed that subsidence began around 60 m before the arrival of the face and then increased to values significantly higher than those predicted for the tunnel section type

adopted. Subsidence of 14 cm was recorded at km 58.690 which increased to 22 cm after the passage of the face (Fig. 10). When the development of subsidence is plotted on a graph as a function of the distance from the face, it can be clearly seen that 60 % of total subsidence occurs before the arrival of the face. A further 30 % occurs in the 20 m following the passage of the face (before the tunnel invert is cast) and the remaining 10 % in the next 40 m.

At the same time total accumulated extrusion measurements of around 10 cm were recorded inside the tunnel together with average radial convergence of around 10–12 cm. Total differential extrusion was well above the alarm threshold that had been set (Fig. 11). This difference between predicted and actual values was mainly due to differences between the real geotechnical situation and the situation forecast by the geological survey campaign on which the predictions were based.

The problem that then had to be tackled was how to calibrate the intensity and distribution of the stabilisation intervention between the face and the cavity to produce an optimum design from the viewpoint of subsidence (damage to the racing track), cost and time (advance past the racing circuit by the end of February 2000).

The following steps were taken to solve the problem (Fig. 12):

1. reconstruction of the real situation by means of mathematical modelling using all the data furnished by the monitoring system (extrusion, convergence and surface subsidence) and a back-analysis procedure in order to determine strength and deforma-



17 Excavation under the racing circuit

tion parameters and the mathematical procedures most suitable to represent the reality;

2. use of the weighted mathematical models from the previous step to calibrate pre-confinement and confinement intervention aimed at maintaining extrusion and subsidence within set maximum limits.

Various finite differences mathematical models, 12 axial-symmetric and 32 plane, were set up to recreate the real situation using FLAC software ver. 3.40 and a strain softening failure criterion which simulated the real stress-strain behaviour of the ground quite faithfully. The new geotechnical parameters found with this method are summarized in Table 1.

Once the models had been weighted so that they repro-

duced, by calculation, the same data furnished by the monitoring system (Fig. 13), they were used:

1. to reconstruct the course of the de-confinement curve as a function of distance from the face for a given cross section of tunnel; knowledge of this curve is essential for reliable analysis using plane models

2. to study the effect of possible pre-confinement and confinement of the cavity.

Axial-symmetric modelling was used to calculate the optimum number of ground improvements required to both guarantee face stability and total accumulated extrusion of not more than 5 cm as specified in the construction design (Fig. 14).

Plane modelling, on the other hand was used to study the effects obtained in terms

of the deformation response of the ground, from controlling extrusion of the core-face with different methods of closing confinement in the tunnel back from the face (Fig. 15):

■ Model A) presence of a tunnel invert rib, casting of the invert in steps of 12 m, casting of the crown at 40 m from the face

■ Model B) presence of a tunnel invert rib, casting of the invert in steps of 4 m, casting of the crown at 40 m from the face

■ Model C) absence of a tunnel invert rib, casting of the invert in steps of 4 m, casting of the crown at 40 m from the face.

On the basis of the results of the mathematical modelling based on monitoring data it was decided to calibrate the construction design as follows (Fig. 16):

■ the use of 93 fibre glass structural elements 24 m in length with a minimum overlap of 12 m for ground improvement of the advance core

■ a tunnel invert rib

■ tunnel invert cast in steps of 12 m

■ expanding cement mixes for cementing the fibre glass structural elements in the advance core.

Table 1: Geo-mechanical parameters of the Mugello basin clays

Parameter	After the survey phase	After the back-analysis
Unit weight	19,9 - 20 kN/m <sup>3</sup>	19,9 - 20 kN/m <sup>3</sup>
Peak effective cohesion	0,02 - 0,03 MPa	0,015 MPa
Residual effective cohesion	0	0
Peak effective angle of friction	24° - 28°	22°
Residual effective angle of friction	15° - 18°	15°
Modulus of elasticity	$E(z) = 11,5 + 3,02 \cdot z$ [MPa]	$E(z) = 11,5 + 0,5 \cdot z$ [MPa]
Over Consolidation Ratio (OCR)	2 - 5	2 - 5

## 7 Operational Phase

Excavation under the racing circuit was performed on the basis of the decisions taken at the therapy phase (Fig. 17) and the design was fine tuned on the basis of monitoring data. The design predictions were faithfully verified both with regard to deformation and advance rates.

The critical zone under the "Borgo San Lorenzo" curve of the racing track was successfully tunnelled with constant advance at an average of 2 m/d of finished tunnel.

## 8 Monitoring phase

The figures that follow summarise the course of the monitoring data recorded, after calibrating the design, while tunnelling under the racing track. It is interesting to see how the progressive decrease in total accumulated extrusion was followed by a corresponding decrease in both tunnel convergence and vertical settlement of the lining itself (Fig. 18). Similarly, total differential extrusion rapidly fell below the alert threshold (Fig. 11). Fig. 19 shows how subsidence values along the centre line of the tunnel were consequently also significantly reduced during the passage under the track: maximum subsidence measured was around 13 cm, within the desired margins. This value, which in itself may be considered high, could easily have been further reduced by appropriately stiffening the advance core (dotted line in the graph in Fig. 19). This, however, could not have been done before the racing season started. The solution adopted not only guaranteed stability and safety during excavation but also turned out to be the

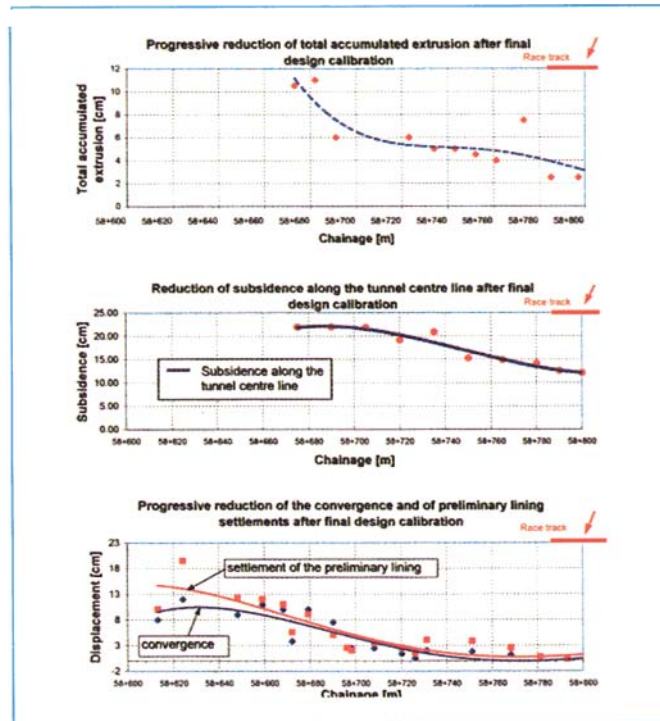

18 The progressive decrease in total accumulated extrusion was followed by a corresponding decrease in both tunnel convergence and vertical settlement of the lining itself (monitoring phase)

best in terms of execution times and costs.

## 9 Conclusions

The case illustrated is taken from experience acquired during the construction of the underground works for the new high-speed railway line between Bologna and Flo-

rence. It shows how the Adeco-RS approach, used for the design and construction of all the tunnels on the line, gives a new and correct interpretation of observational criteria for final design verification and calibration during construction. Calibration here is intended as optimisation and deciding the final distribution

of stabilisation instruments between the face and ground around the cavity in the context of the tunnel section type selected at the design stage.

### Bibliography

- [1] Lunardi P., "Il collegamento ferroviario ad alta velocità tra Bologna e Firenze: „Storia del collegamento“ - „Aspetti progettuali e costruttivi delle opere in sotterraneo“, Gallerie e grandi opere sotterranee, n. 54, 1998 (Italian and English)
- [2] Lunardi P., "L'influenza della rigidità del nucleo d'avanzamento sulla stabilità degli scavi in galleria", Gallerie e grandi opere sotterranee, n. 59 year 1999 (Italian and English)
- [3] Lunardi P., Bindi R., Focaracci A., "Technical and financial planning of underground works: the "Adeco-RS" method", VI Forum Europeo di Ingegneria Economica - Università Bocconi - Milan, 13th-14th May 1993
- [4] Lunardi P., "Progetto e costruzione di gallerie secondo il metodo basato sull'analisi delle deformazioni controllate nelle rocce e nei suoli", (Italian and French), Article in three parts, Quarry and Construction, March 1994, March 1995, April 1996 or Revue Française de Géotechnique, n. 80, 1997, n. 84, 1998, n. 86, 1999
- [5] Lunardi P., "Design and constructing tunnels: A.DE.CO.-RS approach", (English), Tunnels & Tunnelling International Supplement, May 2000
- [6] Kovari, K., Lunardi, P., "On the observational method in tunnelling", International Conference on Geotechnical and Geological Engineering, Melbourne, 19th-24th November 2000

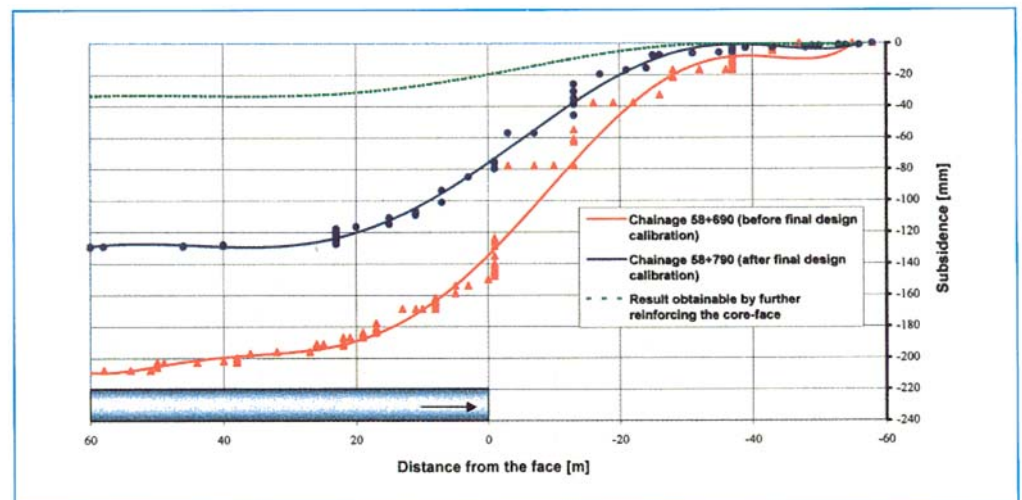

19 Effect of final design calibration on subsidence values (monitoring phase)